

elertus

Setup Guide

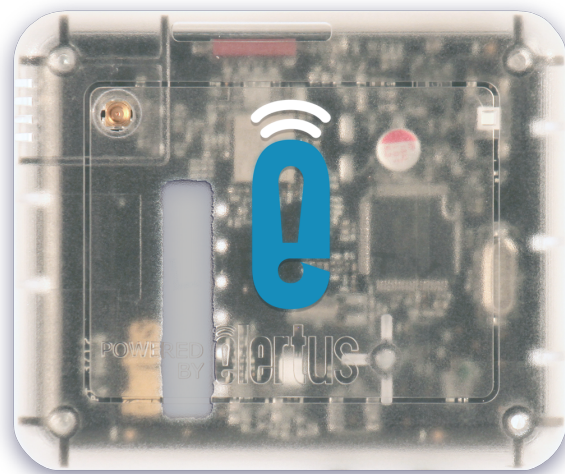

1

Install the batteries into your Elertus Sensor, and wait for the LED light to turn solid **RED**.

A slot on the left side of the Elertus Sensor enables you to pry the case open using a flathead screwdriver.



Tip

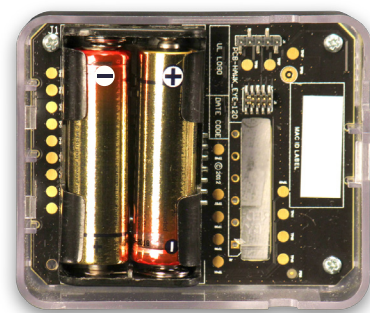

2

Press and hold the little, white button on the front of your Elertus Sensor until the LED light flashes **YELLOW**.

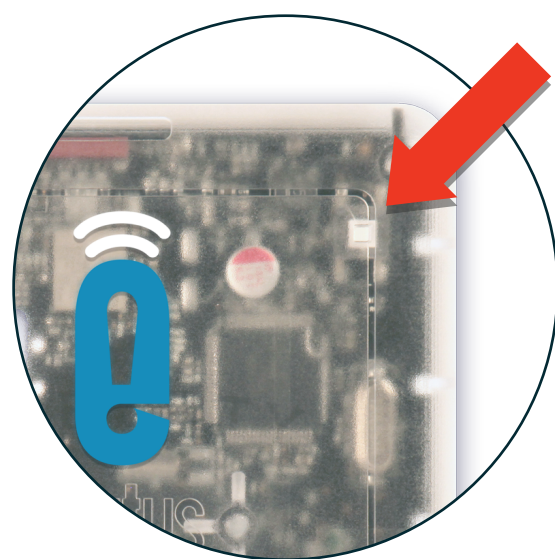

Tip

You may need to hold the button down for up to 15 seconds. The LED may blink other colors before it begins flashing **YELLOW**.

3

When the LED light on your Elertus Sensor is flashing **YELLOW** it is in a special **setup mode**. You can connect to it just like you would your home or business Wi-Fi network.

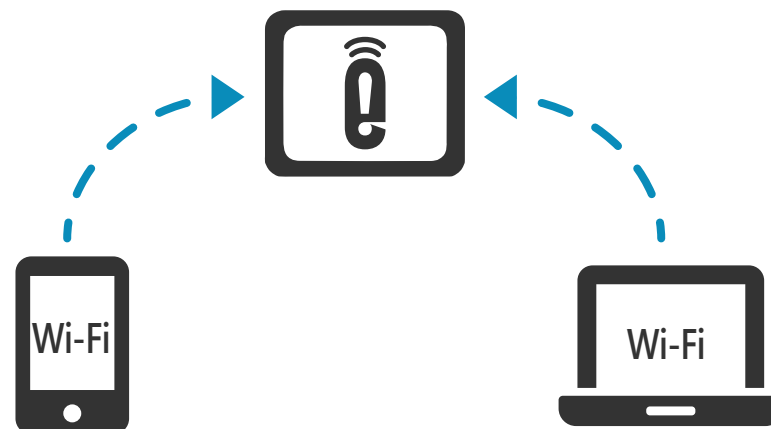

Ensure that Wi-Fi is enabled on your computer, smartphone or tablet, then continue.

4

Go to the wireless (Wi-Fi) settings of your computer, smartphone or tablet. Search for available wireless networks and connect to the Wi-Fi network named **Elertus**.

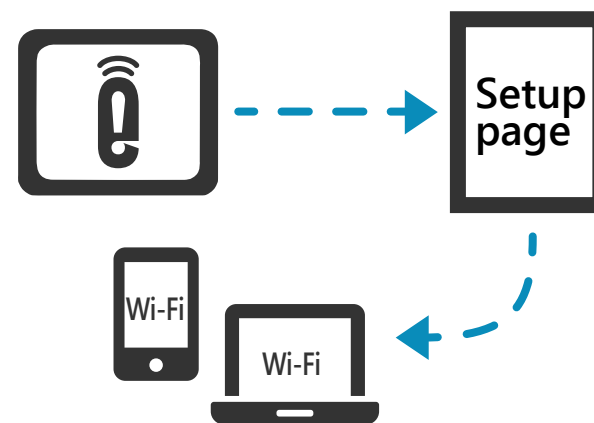

The Elertus Wi-Fi network cannot provide an internet connection, but will provide access to the Elertus setup web page.

5

Open an internet browser on your computer, smartphone or tablet.



Tip

It may show you an error indicating that you do not have an internet connection. This is normal.

In the address bar type: **10.5.5.2** and press Enter or Go.

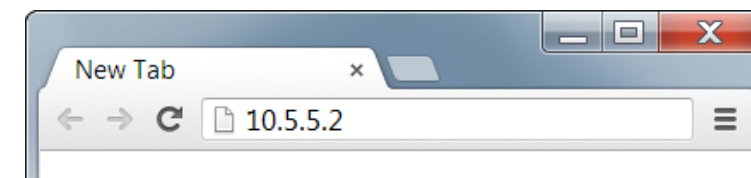

6

Your browser will now load a special Elertus Setup Web Page.

Follow the onscreen instructions to complete your Elertus Sensor setup.

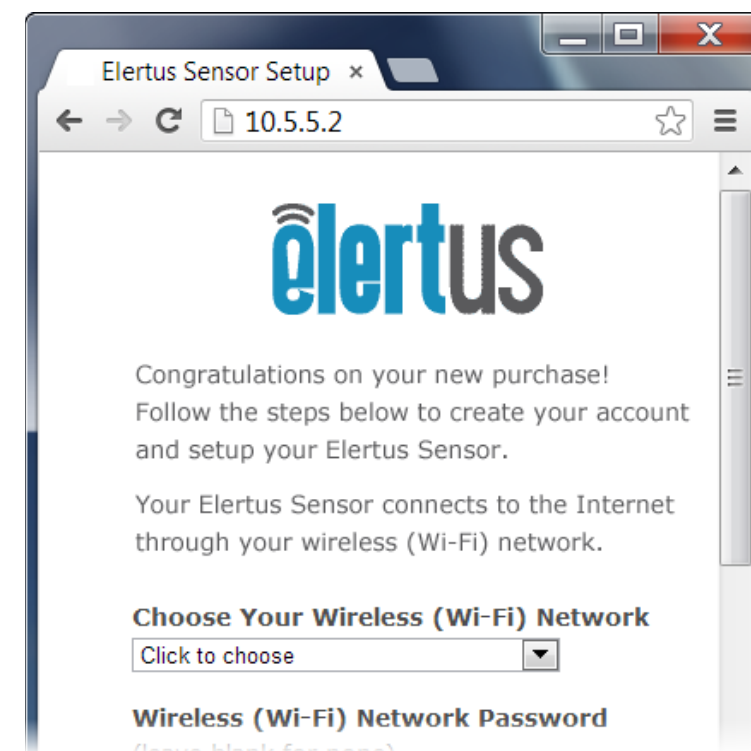

Before You Begin, You Will Need

- Your Elertus Sensor and the included AA batteries.
- A computer, smartphone or tablet with Wi-Fi capability.
- A flat-head screwdriver.
- Your wireless (Wi-Fi) network name and password. To make the setup easier, write them in the space below:

Network Name: _____

Password: _____

What do the Elertus LED lights mean?

 **Flashing YELLOW.** Your Elertus Sensor is in Setup Mode. It will remain in Setup Mode for up to 15 minutes.

What to do: Refer to Step 3 on the front of this guide to setup your Elertus device.

 **Solid GREEN.** You completed the setup and your Elertus sensor connected to the Elertus website successfully.

What to do: Nothing. You are done setting up your Elertus Sensor. The LED will turn off within 30 minutes to save batteries.

 **Solid RED.** You completed the setup but your Elertus Sensor was NOT able to connect to the Elertus website.

What to do: Ensure that you have the correct Name and Password for your Wi-Fi network. Remove the batteries from your Elertus Sensor, then start from Step 1 on the front of this guide.

Using a 3/16" bit, drill four holes into the locations you marked. If the surface is drywall, then insert the included plastic wall anchors. Place the backplate against the surface, carefully aligning it with the holes you just drilled.

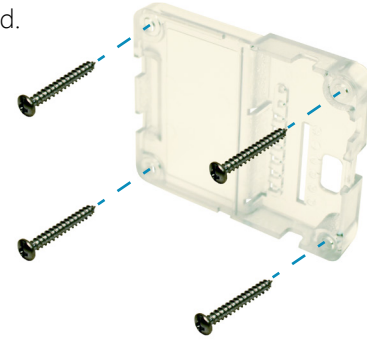

Screw the backplate onto the surface.



Finally, attach the Elertus Sensor to the backplate and you are done.

Installing your Sensor

The Elertus Sensor can simply be placed on a shelf, counter or anywhere else you want to monitor. You can also mount it using the included Velcro strip or screws.

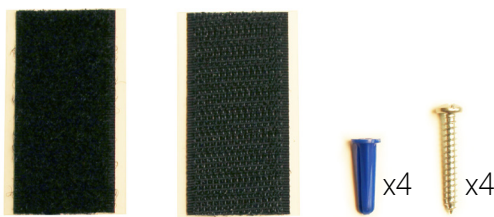

Mounting with Velcro

Adhere the sticky side of the Velcro strip to the flat surface on the back of your Elertus Sensor. Adhere the other piece of Velcro to the location where you want your Elertus Sensor installed.

Mounting with Screws

Remove the backplate from your Elertus Sensor. Hold the backplate against the surface where you want to install your Sensor, and mark the surface through the four screw holes.

Contact Us

Support: 801.657.5352, x.1
Sales: 801.657.5352, x.2
support@elertus.com
www.elertus.com/contact
controlcenter.elertus.com/support



Tip Before you can Sign In to the smartphone app or the Online Control Center you must complete the Elertus Sensor setup and account activation. Please refer to the first side of this manual for help with the setup.

Online Control Center

In addition to the smartphone apps you can edit your Elertus account from a computer browser. To access the online Control Center you can:

- Click the  button at the top of the www.elertus.com website, then click on the **Elertus Control Center** box
- Go directly to controlcenter.elertus.com

Get the Apps

With the free apps for the iPhone®, iPad®, iPod® or Android™ devices you can customize your alerts, add or edit contacts, view the most recent status and receive instant notifications.

Download them for free on the App Store or Google Play. You can find them by scanning the QR codes below or by searching for **Elertus**.



Specifications

Power Source:	Two (2) AA 1.5V alkaline batteries
Power Usage:	1 year battery life with typical usage
Temperature Range:	-20°F to 150°F
Humidity Range:	0% to 90% (non-condensing)
Dimensions (LxWxH):	3.1"(L) x 2.6"(W) x 1.05"(H) (78.7mm x 65.7mm x 26.6mm)
Communications:	The Elertus Sensor operates as a client device using industry-standard Wi-Fi® (8.2.11G)

Regulatory Compliance

The Elertus Sensor complies with relevant standards established by the following regulatory bodies: Federal Communications Commission (FCC), Conformité Européene (CE), Industry Canada, and Restriction of Hazardous Substances (RoHS).

FCC

FCC ID: MHI-ELRT10

This device complies with Part 15 of the FCC Rules. Operation is subject to the following two conditions: (1) this device may not cause harmful interference, and (2) this device must accept any interference received, including interference that may cause undesired operation.

This equipment has been tested and found to comply with the limits for a Class B digital device, pursuant to Part 15 of the FCC Rules. These limits are designed to provide reasonable protection against harmful interference in a residential installation. This equipment generates, uses, and can radiate radio frequency energy and, if not installed and used in accordance with the instructions, may cause harmful interference to radio communications. However, there is no guarantee that interference will not occur in a particular installation. If this equipment does cause harmful interference to radio or television reception, which can be determined by turning the equipment off and on, the user is encouraged to try to correct the interference by one or more of the following measures:

- Re-orient or relocate the Elertus Sensor.
- Increase the separation between the equipment and receiver.
- Consult the dealer or an experienced radio/TV technician for help.

IMPORTANT! Changes or modifications not expressly approved by Elertus void the user's authority to operate the equipment.

FCC Radiation Exposure Statement

This equipment complies with FCC radiation exposure limits set forth for an uncontrolled environment. This equipment should be installed and operated with minimum distance 20cm between the radiator and your body.

CE

We, Elertus, of 11778 South Election Road, Suite 260, Salt Lake City, Utah, 84020 USA, declare under our sole responsibility that the product, the Elertus Sensor, Model Number ELRT10, to which this declaration relates, is in conformity with the following standards and/or

other normative documents:

EN60950, EN55022, EN55024

We hereby declare that the above named product is in conformity with the essential requirements and other relevant provisions of Directive 1999/5/EC.

The conformity assessment procedure referred to in Article 10(3) and detailed in Annex II of Directive 1999/5/EC has been followed.

Industry Canada

IC: 3681C-ELRT10

This class B digital apparatus complies with Canadian ICES-003.

CET appareil numérique de la classe B est conforme à la norme NMB-003 du Canada'

Important Note: Radiation Exposure Statement

This equipment complies with IC radiation exposure limits set forth for an uncontrolled environment. This equipment should be installed and operated with minimum distance 20cm between the radiator and your body.

Note Importante: (Pour l'utilisation de dispositifs mobiles)

Declaration d'exposition aux radiations

Cet équipement est conforme aux limites d'exposition aux rayonnements IC établies pour un environnement non contrôlé. Cet équipement doit être installé et utilisé avec un minimum de 20 cm de distance entre la source de rayonnement et votre corps.

This device complies with Industry Canada license-exempt RSS standard(s). Operation is subject to the following two conditions: (1) this device may not cause interference, and (2) this device must accept any interference, including interference that may cause undesired operation of the device.

Le présent appareil est conforme aux CNR d'Industrie Canada applicables aux appareils radio exempts de licence. L'exploitation est autorisée aux deux conditions suivantes: (1) l'appareil ne doit pas produire de brouillage, et (2) l'utilisateur de l'appareil doit accepter tout brouillage radioélectrique subi, même si le brouillage est susceptible d'en compromettre le fonctionnement.

Restriction of Hazardous Substances (RoHS)

All parts in the Elertus Sensor meet the material restrictions of RoHS, as proposed by the RoHS Technical Adaptation Committee. This is based upon information provided by suppliers of the raw materials used by Elertus to manufacture these products. As such, Elertus makes no independent representations or warranties.

One-Year Limited Warranty

This product is warranted to be free of defects in material and workmanship for one year from date of activation.

Elertus will, at its election and as the purchaser's or end user's sole and exclusive remedy for any breach of the limited warranty set forth above, repair or replace this product if a defect in material or workmanship is identified and communicated to Elertus within the one-year period described above. Elertus is not responsible for removal or reinstallation costs. This warranty is not valid in cases where damage to this product is the result or arises out of misuse, abuse, incorrect repair or improper wiring or installation.

To notify Elertus of any breach of the foregoing limited warranty and to obtain warranty service, contact Elertus Customer Support by e-mail to support@elertus.com or by calling 801-657-5352 x.1, to obtain a Return Materials Authorization ("RMA") number and instructions for returning your defective product to Elertus.

IMPLIED WARRANTIES, INCLUDING THOSE OF MERCHANTABILITY AND FITNESS FOR A PARTICULAR PURPOSE, ARE EXPRESSLY DISCLAIMED, EXCEPT WHERE SUCH DISCLAIMER IS PROHIBITED BY APPLICABLE LAW. ELERTUS AND/OR THE SELLER DISCLAIM(S) ANY AND ALL LIABILITY FOR SPECIAL, INCIDENTAL AND CONSEQUENTIAL DAMAGE IN ANY WAY ASSOCIATED WITH OR RELATED TO THE PURCHASE, INSTALLATION AND/OR USE OF THIS PRODUCT.

Some states/provinces do not allow limitations on how long an implied warranty lasts, or the exclusion or limitation of special, incidental or consequential damages, so these limitations and exclusions may not apply to you. This warranty gives you specific legal rights. You may also have other rights which vary from state/province to state/province.

This is Elertus' exclusive written warranty.

About This Document

Copyright © 2013, Elertus All rights reserved. Elertus is a trademark of Card Access Products, LLC.

Other marks may be the property of their respective owners.